

# Large Venue Catalogue

---

The large projection screen range



**SCREENLINE**  
the screen makes the difference

# Large Venue

Screenline offers a wide range of large screens.  
 Motorized screens can reach 12 m.  
 The frame range thanks to the modular system has no size limit.

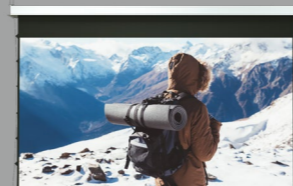

Maximilian  
2.0 standard

Maximilian  
2.0 pro

Lodo  
Evolution  
Lodo Evolution  
tensioned

Big Lodo  
Evolution  
Big Lodo  
tensioned Evo

Lodo  
Inceiling  
Lodo Inceiling  
tensioned

Inceiling  
Big Lodo

New Big  
Frame

New Only  
White

Vertical

Base from  
800 up to  
1200 cm.

Base from  
800 up to  
1200 cm.

Base from  
400 up to  
700 cm.

Base from  
700 up to  
850 cm.

Base from  
400 up to  
700 cm.

Base from  
700 up to  
850 cm.

Base from  
450 up to  
1600 cm.

Base from  
450 up to  
1600 cm.

For screens  
up to  
700 cm.

# Maximilian 2.0 standard

The most large venue screen

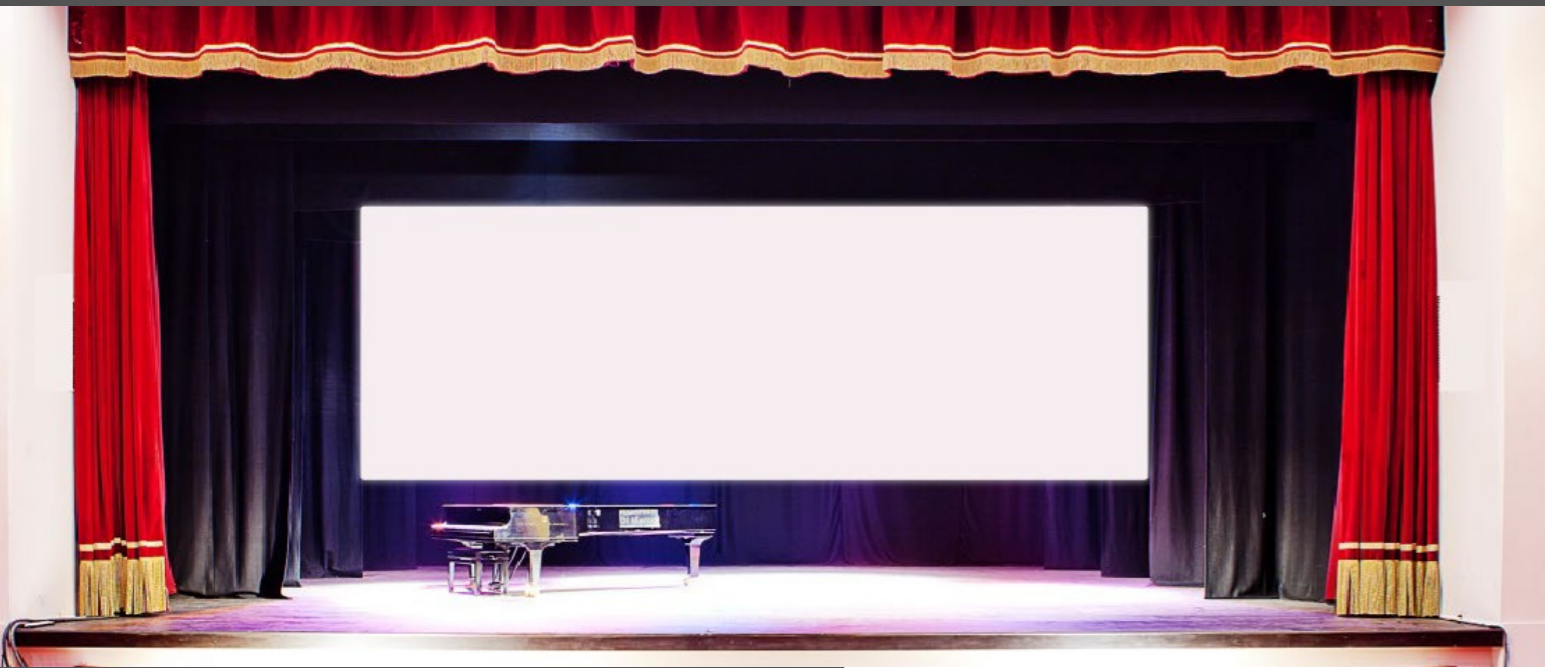

 Base from 800 up to 1200 cm.



## Fabrics



## Polichinelle system

With "Polichinelle" system the wrapping tube goes down to the lower end stroke while unwrapping the projection fabric until it is completely open. The system uses two lateral cables to put the tube in motion. In our screen, the two cables are replaced by two stainless steel belts which, when wrapping up, avoid any possible overlapping or derailment.



## Brackets

Eyebolt lifting brackets



Ceiling mount brackets

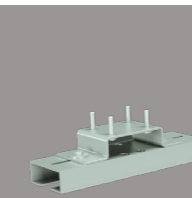

High Ceiling mount brackets



Truss mount brackets

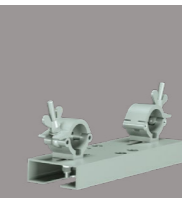

Hoist chains



## New improved version

- No more junctions: one piece rolling tube
- 15% lighter than previous versions
- Double speed 0,50 m/s thanks to the new motor: 70 -120 rpm
- Replaced steel cables with steel belts: quieter and safer.
- New motor with additional safety system. Installed on the desired side.
- Control box supplied disconnected (quick plug - in system on board)

## Easy installation

The aluminium supporting beam on top of the screen holds four sliding plates which allow the installation of the screen with clamps and brackets suitable for concrete, steel or wooden beams.

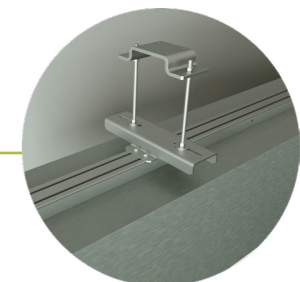

## Key features

- Motorized screen of "polichinelle" system
- The wrapping tube goes down thanks to 4 stainless
- Stainless steel belts with safety blocks at the two extremities
- Side motor with motion transmission through rotating axles
- Black case

## New Service Screen Assembly on site.

- Screenline offers transportation, portorage and screen assembly service in a theater. We will pack the screen in packages with dimensions congruent to the space available for the access to the theater and we will assemble it on site.
- Our team will deliver it perfectly assembled in the right position to complete the installation.

# Maximilian 2.0 pro

The most large venue screen



Base from 800 up to 1200 cm.



THEATRE



WORSHIP

## Fabrics



Dual face



Home vision



Coral



Perforated



White Ice



## Key features

- Motorized screen of "polichinelle" system
- The wrapping tube goes down thanks to 4 stainless steel belts
- Stainless steel belts with safety blocks at the two extremities
- Side motor with motion transmission through rotating axles
- Black case



## Pro version

- Double steel belts
- **New Service Screen Assembly on site.**
- Screenline offers transportation, portorage and screen assembly service in theaters. We will pack the screen in packages with dimensions congruent to the space available for the access to the theater and we will assemble it on site.
- Our team will deliver it perfectly assembled in the right position to complete the installation.

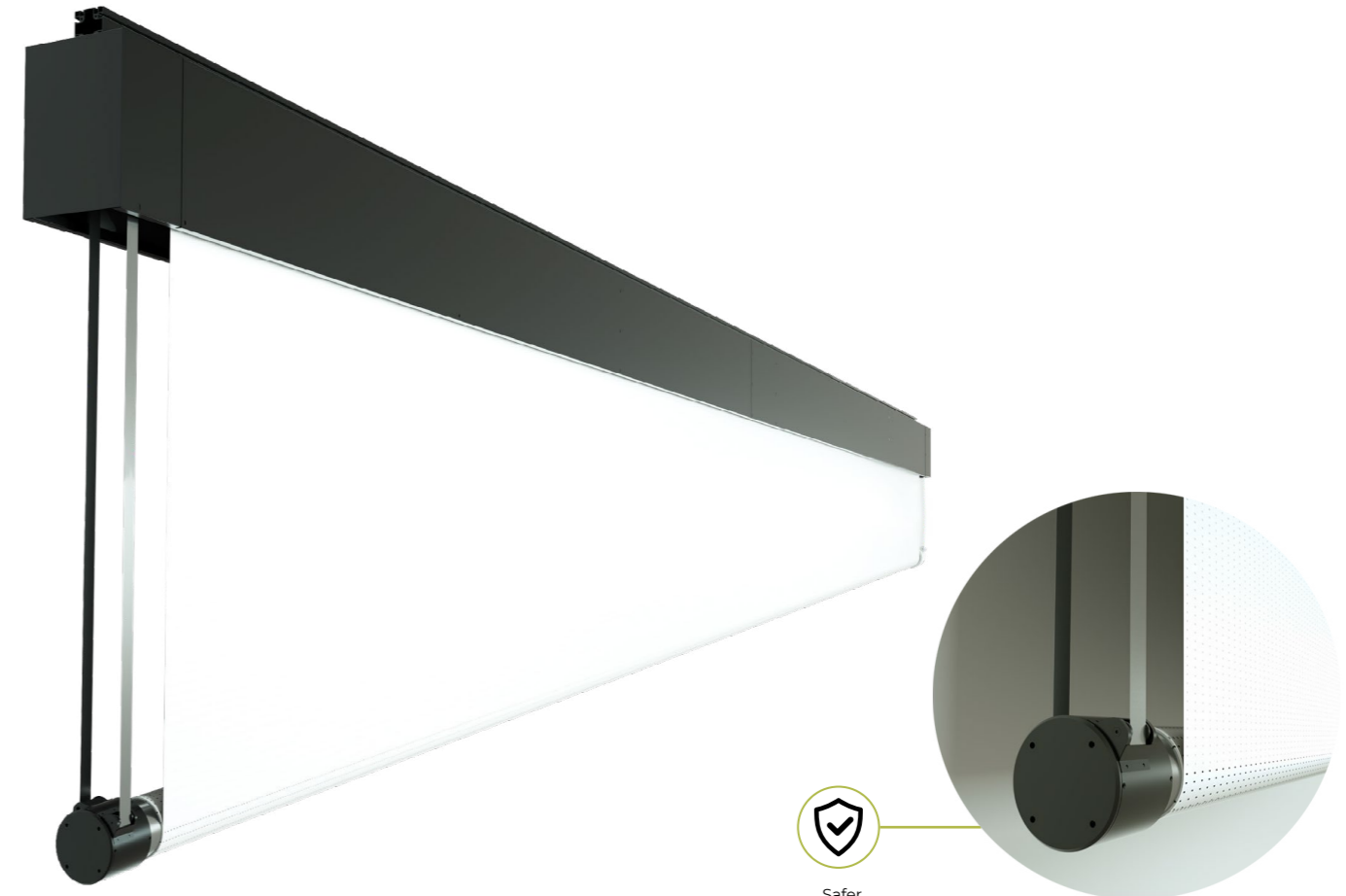

## Brackets

Eyebolt lifting brackets



Ceiling mount brackets

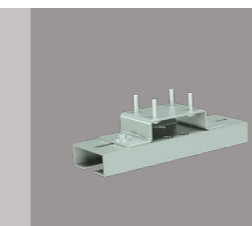

High Ceiling mount brackets

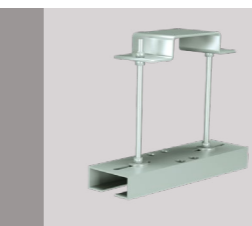

Truss mount brackets

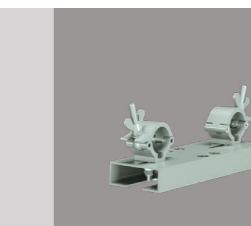

Hoist chains



## Features

- No more junctions: one piece rolling tube
- 15% lighter then previous versions
- Double speed 0,50 m/s thanks to the new motor: 70 -120 rpm
- Replaced steel cables with steel belts: quieter and safer.
- New motor with additional safety system. installed on the desired side.
- Control box supplied disconnected (quick plug - in system on board)

## Easy installation

- The aluminium supporting beam on top of the screen holds four sliding plates which allow the installation of the screen with clamps and brackets suitable for concrete, steel or wooden beams.

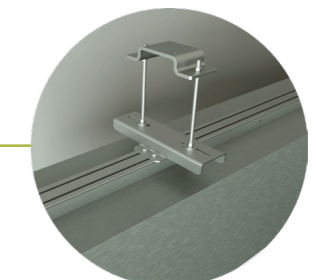

# Lodo Evolution

## Lodo Tensioned Evolution

The large-sized professional screen.

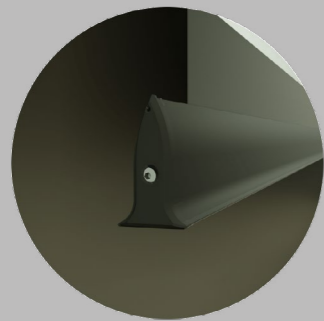

Black



White



Base from 400 up to 700 cm.



THEATRE



WORSHIP



CORPORATE



EDUCATIONAL



MUSEUM

### Fabrics



Home vision



Coral



Perforated



White Ice



### Key features

- For Large venues
- Perfect integration of the counterweight in the box in the long run.
- Side motor with motion transmission through rotating axles
- Anti - droop - fabric.



### Features

- Lodo is both sturdy and practical: the mechanism made of robust aluminium components allows the installation of fabrics. Wide at the base.
- The brackets allow wall or ceiling installation, choosing the distance of the screen from the wall and make it possible to correct the central position also once installed.



Lodo Evolution

Lodo Evolution Tensioned

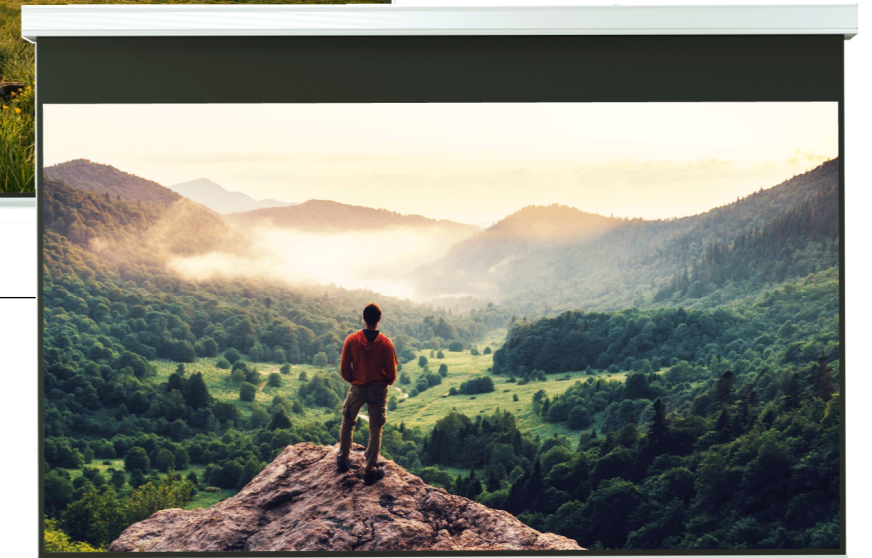

### Brackets

For wall and ceiling installation

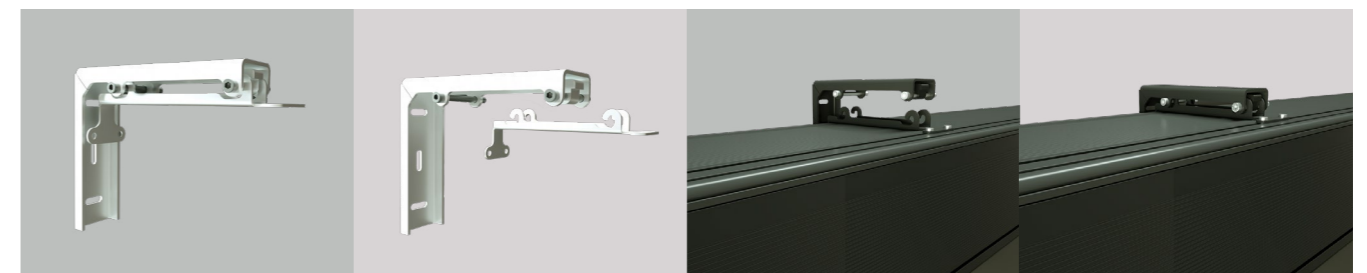

### Tubular motor

- Smart force measurement.
- Automatic block when counterweight is stuck in.
- Limit switches are factory set guaranteeing a long life span.

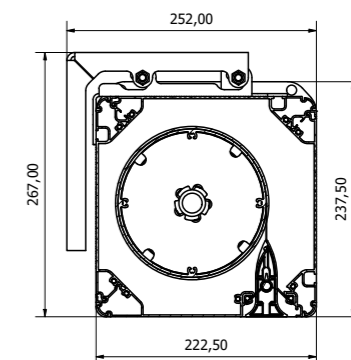

# Big Lodo Evolution Big Lodo Tensioned Evo

The large-sized professional screen.



Base from 700 up to 850 cm.



## Fabrics



Home vision

Coral

Perforated

White Ice



## Key features

- For Large venues
- Perfect integration of the counterweight in the box in the long run.
- Anti - droop - fabric.
- Available black or white



## Features

- Lodo is both sturdy and practical: the mechanism made of robust aluminium components allows the installation of fabrics Wide at the base.
- The brackets allow wall or ceiling installation, choosing the distance of the screen from the wall and make it possible to correct the central position also once installed. The chains make it easy to lift and move the screen. Once they are anchored, they are a further safety measure.



Big Lodo Evolution

Big Lodo Evolution Tensioned



## Brackets

For wall and ceiling installation

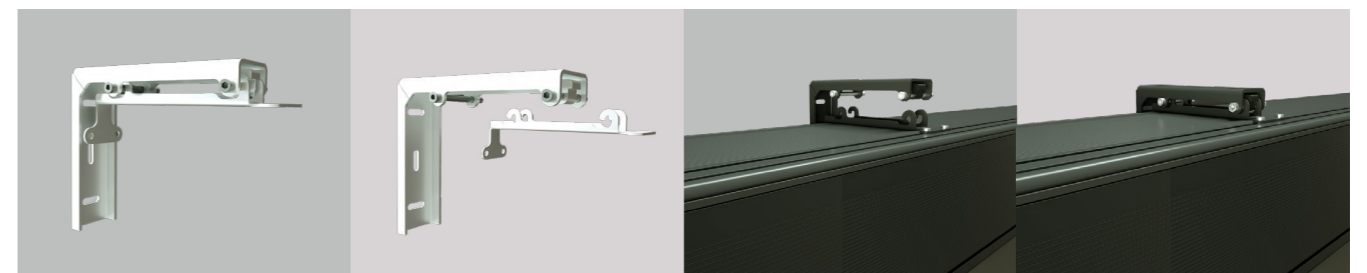

## Tubular motor

- Smart force measurement.
- Automatic block when counterweight is stuck in.
- Limit switches are factory set guaranteeing a long life span.

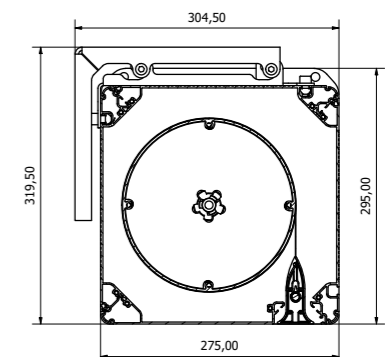

# Lodo Inceiling Lodo Inceiling Tensioned

Motorized concealed screen.



Base from 400 up to 700 cm.



THEATRE



WORSHIP



CORPORATE



EDUCATIONAL



MUSEUM

## Fabrics



Home vision



Coral



Perforated



White Ice



## Key features

- For Large venues
- Perfect integration of the counterweight in the box in the long run.
- Anti - droop - fabric.



## Features

- Neat, fully closed finish.
- The weighted bar has a flat base which sits fully flush into the screen case for beautiful aesthetic appearance when the screen is closed.

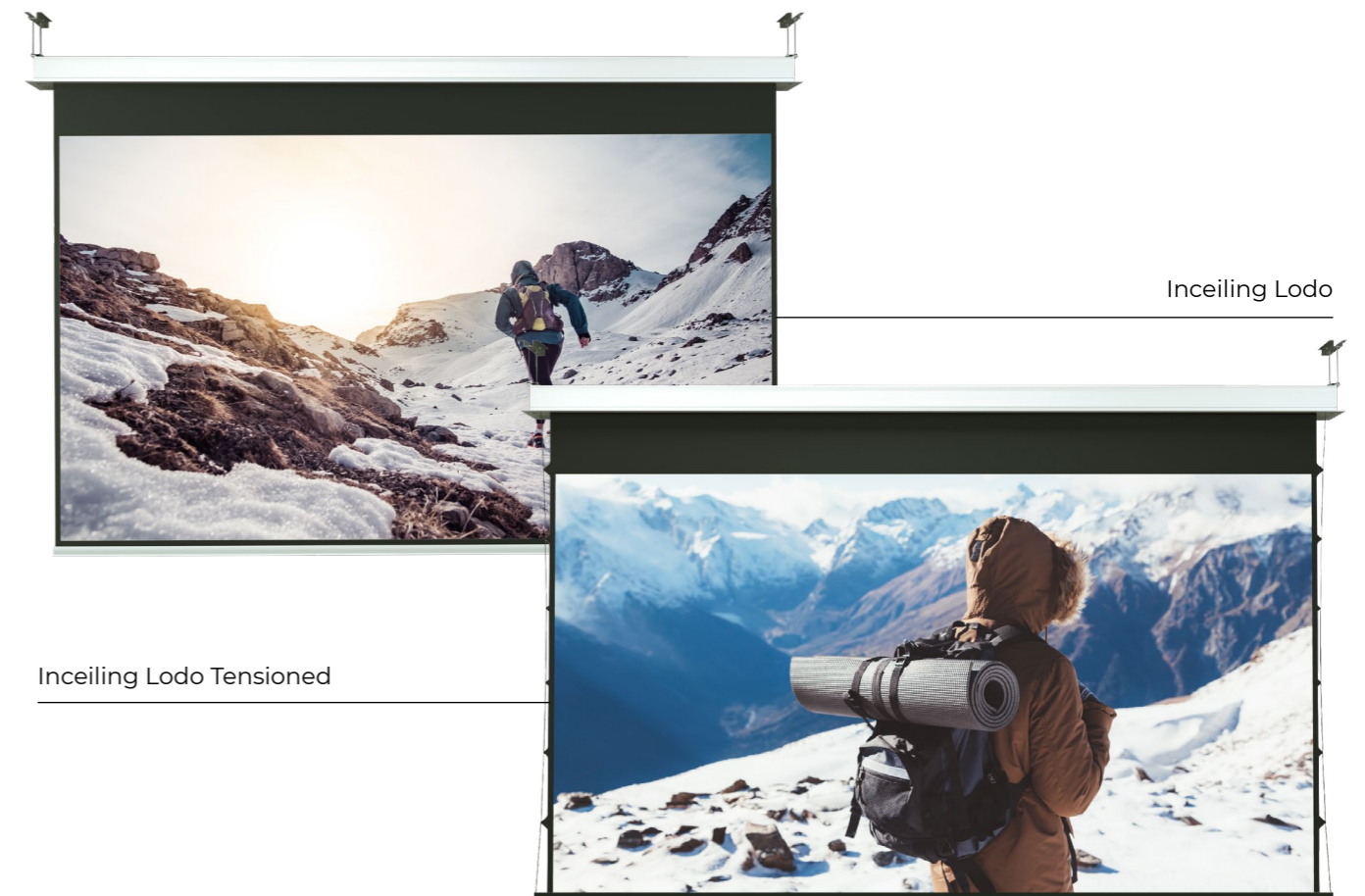

## Tubular motor

- Smart force measurement.
- Automatic block when counterweight is stuck in.
- Limit switches are factory set guaranteeing a long life span.

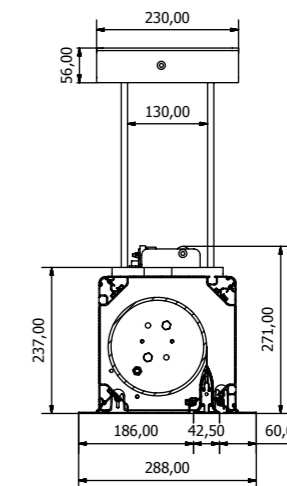

# Big Lodo Inceiling

# Big Lodo Inceiling Tensioned

Motorized concealed screen.

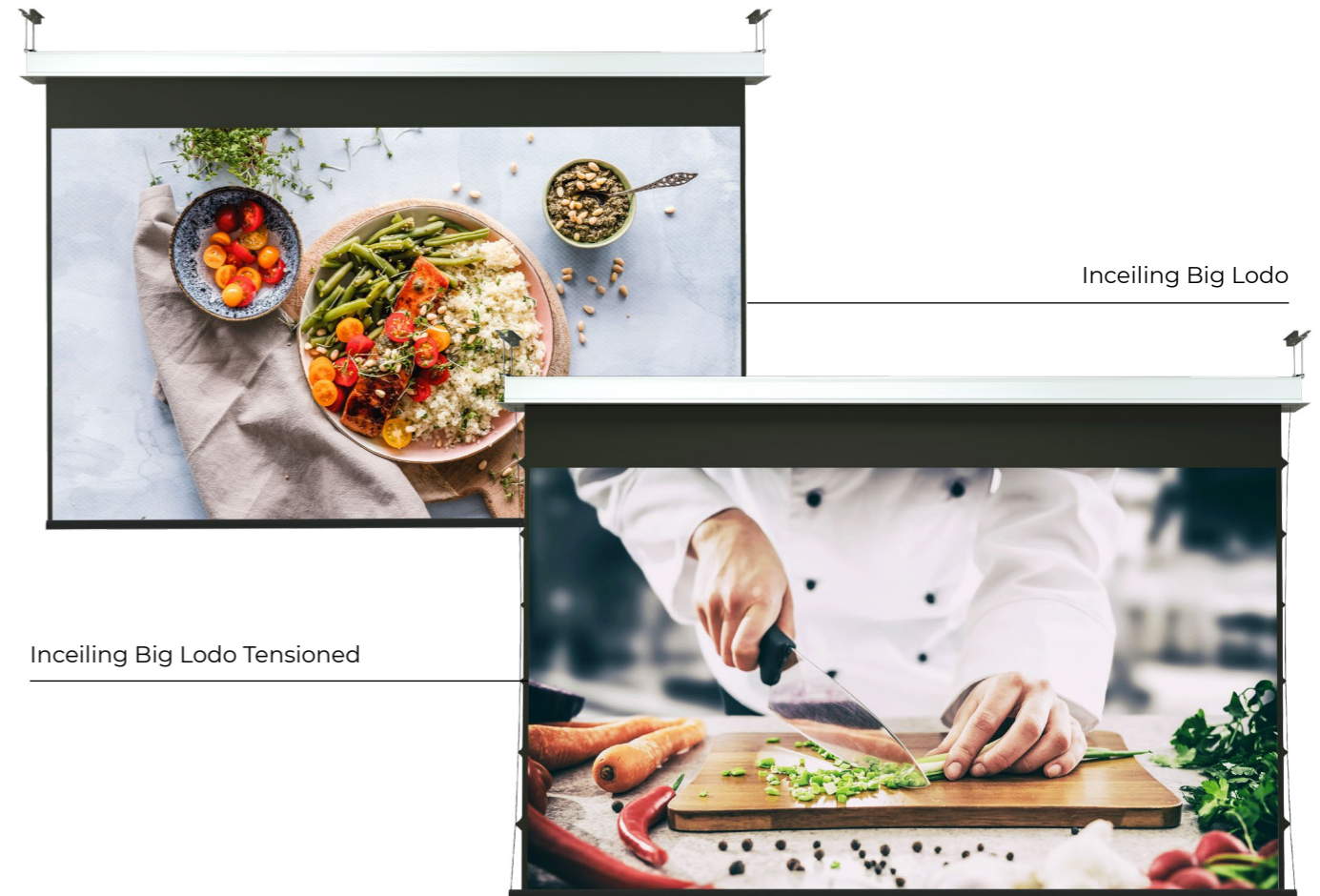
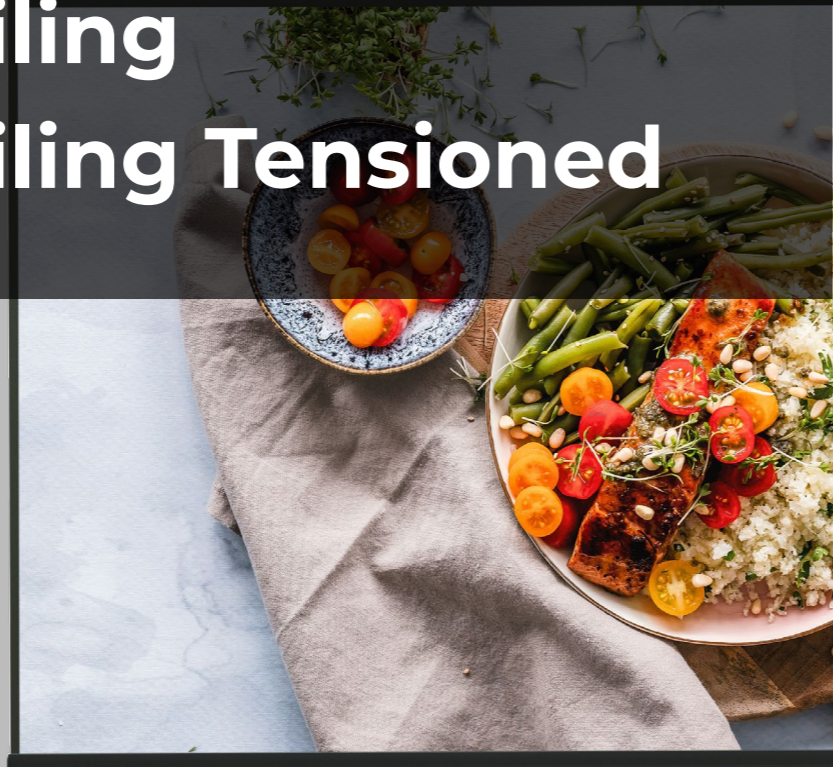

Inceiling Big Lodo

Inceiling Big Lodo Tensioned



Base from 700 up to 850 cm.



THEATRE



WORSHIP



CORPORATE



EDUCATIONAL



MUSEUM

## Fabrics



Home vision



Coral



Perforated



White Ice



## Key features

- For Large venues
- Perfect integration of the counterweight in the box in the long run.
- Anti - droop - fabric.



## Features

- Neat, fully closed finish.
- The weighted bar has a flat base which sits fully flush into the screen case for beautiful aesthetic appearance when the screen is closed.

## Brackets



## Tubular motor

- Smart force measurement.
- Automatic block when counterweight is stuck in.
- Silent soft brake.
- Limit switches are factory set guaranteeing a long life span.

## Technical drawing

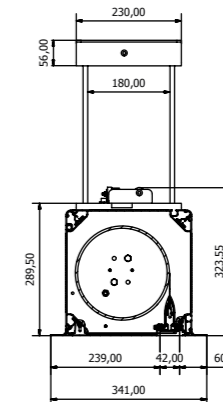



# New Big Frame

For large venue



Base from 450 cm up to 1600 cm  
Thanks to the modular system New Big Frame can reach over 40m.



THEATRE



WORSHIP



CORPORATE



EDUCATIONAL



MUSEUM

## Fabrics



Diamond  
4K



Microperforated  
M



Perforated  
P



Dual face  
Df  
4K



Ambra  
Am  
4K



## Key features

- For Large venues
- Easy and fast fabric installation with pressure arrow border
- Robust frame
- Various positioning accessories
- Extremely versatile in many applications
- Also available with pins system



## Features

- Fast:** New frame with arrow borders. Easily installed thanks to the snap-on fabric positioned inside the dedicated groove, replacing the slow installation of the old eyelet frames.
- Smart:** 5 fixing grooves allow coping with the stretching and shrinking of the fabric.
- Clean:** No more spots or abrasions on the fabric. Now the placement of the fabric is made side up.



## Modular system

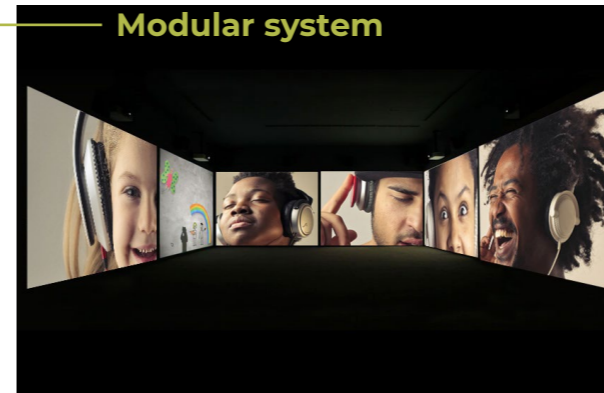

## Brackets

Brackets



Stands



Eyebolts



Aliscraf clamps



Feet



## Fabric installation with pressure arrow borders

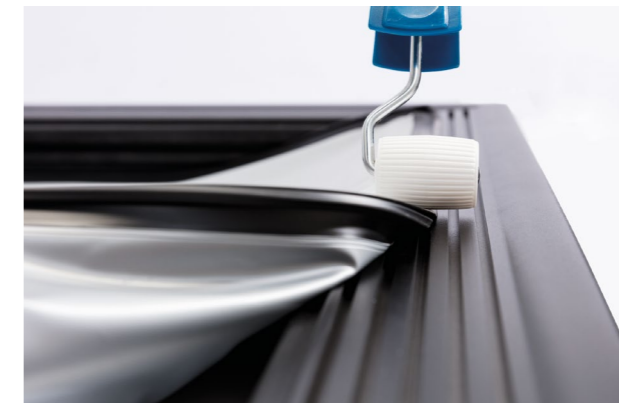

# New Only White

Full vision



Easy Installation



Base from 450 cm up to 1600 cm - Thanks to the modular system New Big Frame can reach over 40m.



THEATRE



WORSHIP



CORPORATE



EDUCATIONAL



MUSEUM

## Fabrics



Diamond

Microperforated

Perforated

Dual face

Ambra



## Features

Simply white, perfectly flat and clean, New Only White stands out for its elegance and harmony in any application, satisfying the requirements and tastes of the most demanding client. New Only White has the same frame of New Big Frame: The frame itself provides full vision. By simply fixing a larger fabric in the rear groove of the frame we obtain a perfectly flat, completely white screen of remarkable dimensions.

Fast and clean installation remains an absolute prerogative of this new screen even though its main quality is beauty.



Versatile / modular system

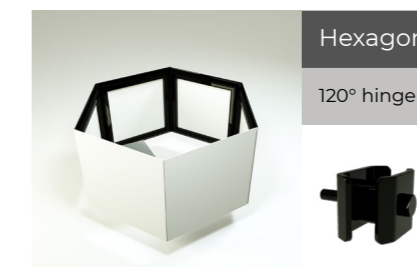
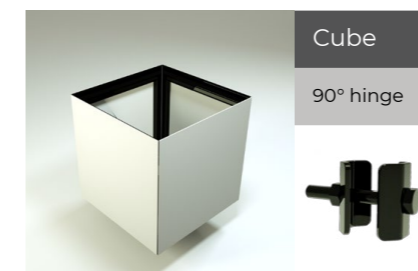

# Vertikal

Lifting screen



It can lift screens from 300 base viewing area up to 700 cm



## Features

Lift for screens up to 7 meters viewing area base.  
Modular system with 2 drums. Maximum height 500 cm.  
Tubular motor with integrated electromechanical brake.



## Available for

- MOT
- JAGO
- COPERNICO
- LODO
- LODO EVOLUTION



## Technical Features

- 3 anchor points
- 2 steel belts
- Max height steel belts: 5m



Max height 500 cm

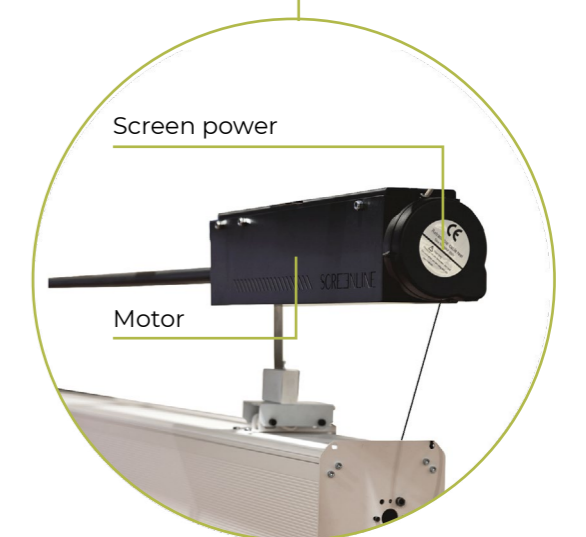

## Versatile / modular system

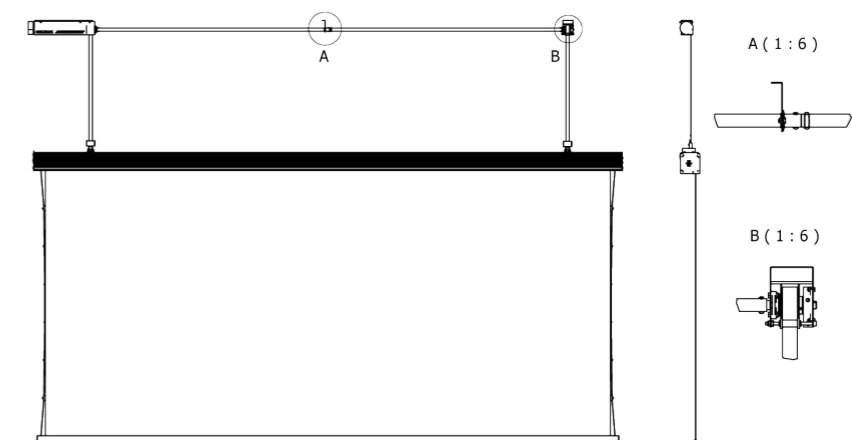





**Screenline S.R.L**

📍 38060 Besenello (TN)  
Via Nazionale, 1/n - 1/u

☎ +39 0464 830003

✉ info@screenline.it

🌐 www.screenline.it

**SCREENLINE**  
the screen makes the difference

Screen designers and manufacturers of Italy

